

REV.	ECN NO.	DESCRIPTION	DRAW	APPD.	DATE
A	---				

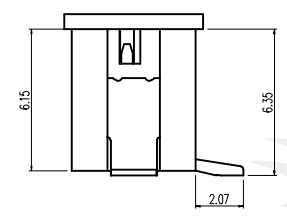

- SPECIFICATIONS**
- Current Rating: 2A AC, DC
 - Voltage Rating: 250V AC, DC
 - Temperature Range: -25 °C ~ +85 °C
 - Contact Resistance: 20mΩ Max
 - Insulation Resistance: 1000MΩ Min
 - Withstanding Voltage: 500V AC/minute
 - Material: LCP UL94V-0
- PIN brass Tin-plated
Solder pad brass Tin-plated

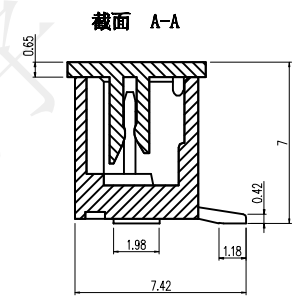
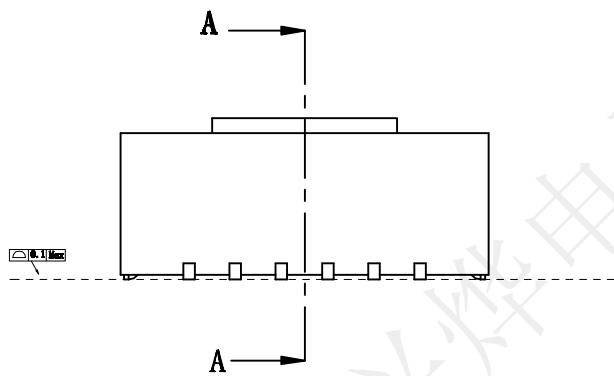
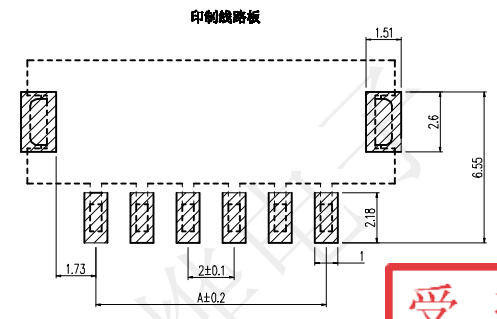
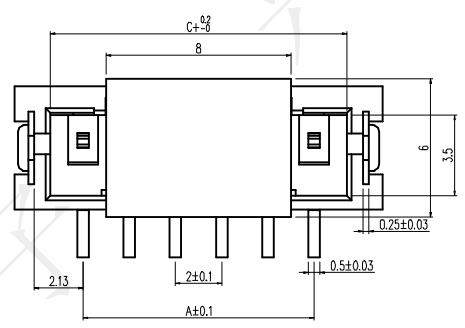

受控文件

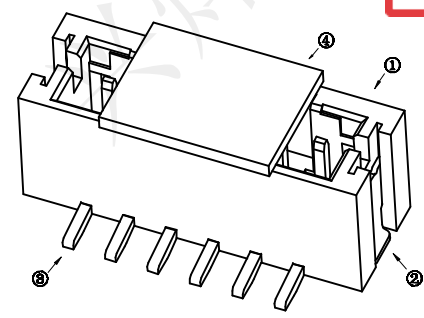
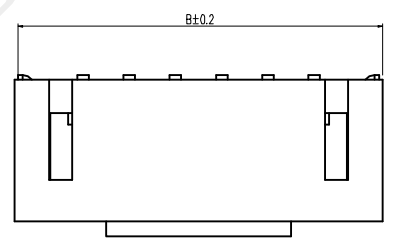

PIN数	料号	尺寸		
		A	B	C
2P	TZH24293	2.00	7.90	4.85
3P	TZH24294	4.00	9.90	6.85
4P	TZH24295	6.00	11.90	8.85
5P	TZH24296	8.00	13.90	10.85
6P	TZH24297	10.00	15.90	12.85
7P	TZH24298	12.00	17.90	14.85
8P	TZH24299	14.00	19.90	16.85
9P	TZH24300	16.00	21.90	18.85
10P	TZH24301	18.00	23.90	20.85
11P	TZH24302	20.00	25.90	22.85
12P	TZH24303	22.00	27.90	24.85
13P	TZH24304	24.00	29.90	26.85
14P	TZH24305	26.00	31.90	28.85
15P	TZH24306	28.00	33.90	30.85
16P	TZH24307	30.00	35.90	32.85
17P	TZH24308	32.00	37.90	34.85
18P	TZH24309	34.00	39.90	36.85
19P	TZH24310	36.00	41.90	38.85
20P	TZH24311	38.00	43.90	40.85

		Series Name : 2.0间距立式贴片		
		Product Description :		
TOLERANCE		Part No:		
.XX	±0.30	X.°	±2°	APPD: 姚人凤
.XX	±0.20	X.°	±1°	CHEd: 施立敏
.XXX	±0.10	.XX°	±0.5°	DRAW: 马洪飞
UNITS	mm	SCALE: 1:1 SHEET: 1/1 REV: A1		