

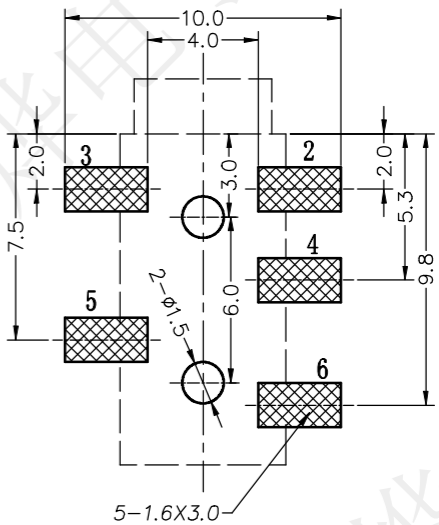

REV.	ECN NO.	DESCRIPTION	DRAW	APPD.	DATE
A	---				

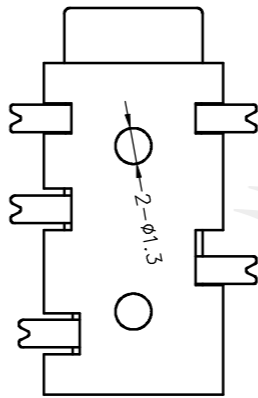

P.C.B LAYOUT TOP VIEW

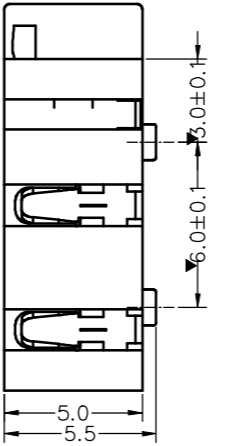
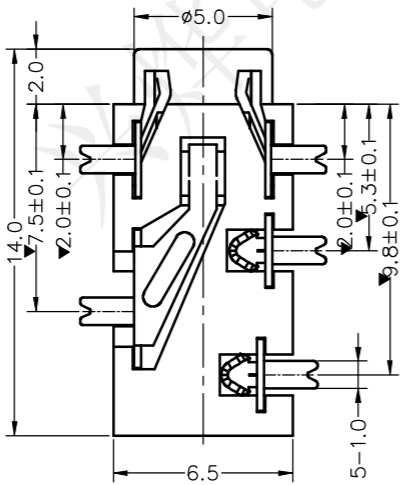
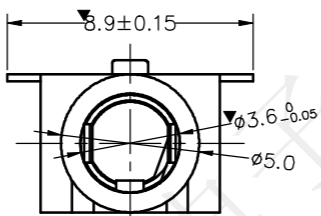
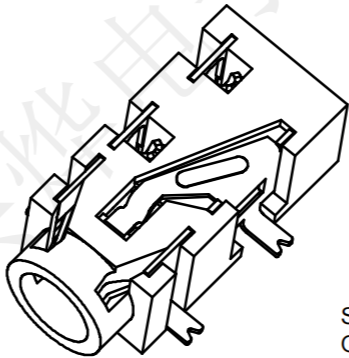
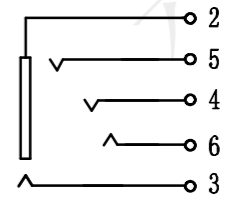

SPECIFICATION:
 Operating temperature:-30℃~70℃
 Rated loading:DC 30V 0.5A
 Contact resistance:30mΩ Max
 Insulation resistance:100MΩ Min
 Withstanding voltage:AC 500V (50Hz) /min
 Insertion force:3-20N
 Pullout force:3-20N
 Life: 5000 CYCLES

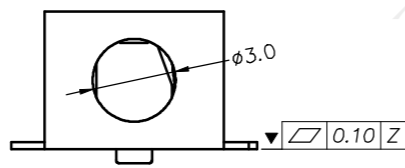
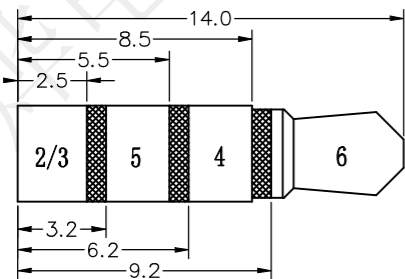

受控文件

5	PJ-327F-05	大脚	1	磷铜	0.25T	镀银
4	PJ-327F-04	中脚	2	磷铜	0.25T	镀银
3	PJ-327F-03	右脚	1	磷铜	0.2T	镀银
2	PJ-327F-02	左脚	1	磷铜	0.2T	镀银
1	PJ-327F-01	基座	1	PPA		黑色
序号	产品编号	产品名称	数量	材料	规格	处理

深圳市兴烨电子有限公司
 Shenzhen XingYe Electronics co., Ltd

TOLERANCE		
X.X ±0.30	X.° ±2°	APPD: 陈爱光
.XX ±0.20	.X° ±1°	CHED: 施立敏
.XXX ±0.10	.XX° ±0.5°	DRAW: 马洪飞
UNITS	mm	

Series Name :		
Product Name :	PJ-327F	
Part NO:	PJL22035	
SCALE	SHEET	REV.
1:1	1/1	A1