

REV.	ECN NO.	DESCRIPTION	DRAW	APPD.	DATE
A	---				

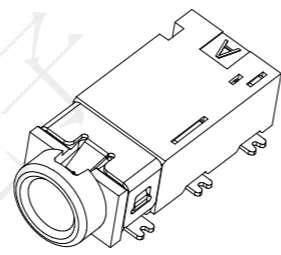

3D VIEW

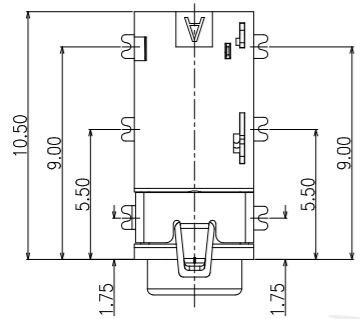
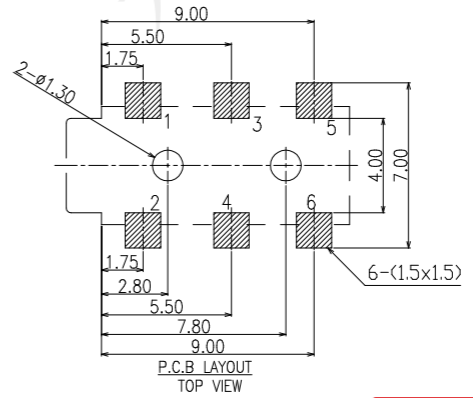
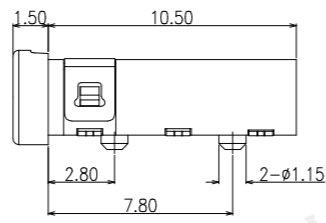
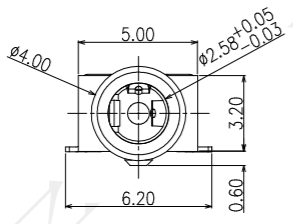

- CONTACT CURRENT RATING: 1A.
- CONTACT RESISTANCE: 100 mΩ MAX.;
- INSULATION RESISTANCE: 100MΩ MIN.;
- DIELECTRIC WITHSTANDING: 500V AC MIN.;
- DURABILITY: 5,000 CYCLES MIN.;
- CONNECTOR MATING FORCES: 30N MAX.;
- CONNECTOR UNMATING FORCES: 3N MIN.;

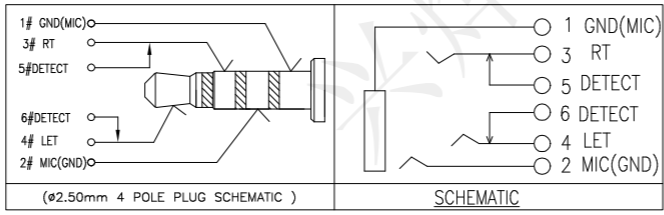
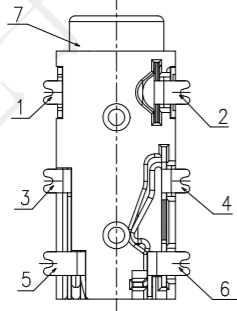

受控文件

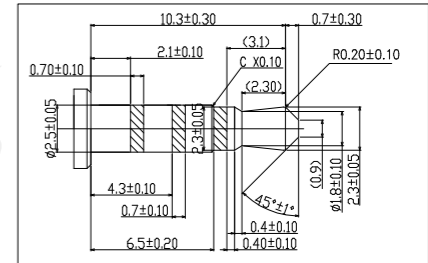

(φ2.50mm 4 POLE PLUG DETAIL DRAWING)

ITEM	NAME	QTY	DESCRIPTION	NOTE
7	HOUSING	1	HIGHT TEMPERATURE PLASTIC; COLOR BLACK	
6	TERMINAL 6#	1	COPPER ALLOY; NICKEL UNDER PLATING OVERALL, GOLD FLASH PLATING ON SOLDER AREA; GOLD FLASH PLATING ON CONTACT AREA	T=0.20mm
5	TERMINAL 5#	1		T=0.20mm
4	TERMINAL 4#	1		T=0.20mm
3	TERMINAL 3#	1	STAINLESS STEEL; NICKEL UNDER PLATING OVERALL, GOLD FLASH PLATING ON SOLDER AREA; GOLD FLASH PLATING ON CONTACT AREA	T=0.20mm
2	TERMINAL 2#	1	COPPER ALLOY; NICKEL UNDER PLATING OVERALL, GOLD FLASH PLATING ON SOLDER AREA; GOLD FLASH PLATING ON CONTACT AREA	T=0.20mm
1	TERMINAL 1#	1	COPPER ALLOY; THE BOTTOM OF THE NICKEL; THE WHOLE GOLD PLATING	T=0.20mm

深圳市兴烨电子有限公司
Shenzhen XingYe Electronics Co., Ltd

TOLERANCE

X.X	±0.30	X.°	±2°
XX	±0.20	.X.°	±1°
XXX	±0.10	.XX.°	±0.5°

UNITS mm

APPD: 陈爱光
CHED: 施立敏
DRAW: 马洪飞

Series Name :		
Product Name :	PJ-242	
Part NO:	PJL21026	
SCALE	SHEET	REV.
1:1	1/1	A1