

REV.	ECN NO.	DESCRIPTION	DRAW	APPD.	DATE
A	---				

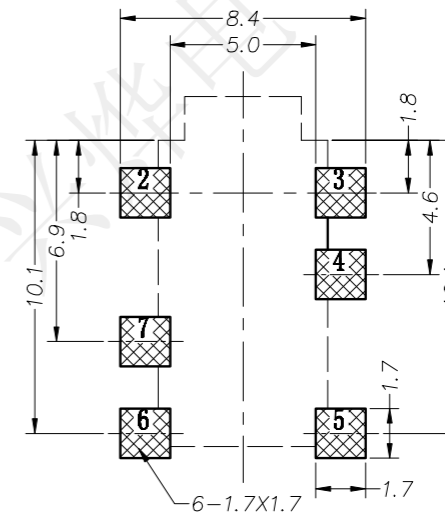

P.C.B LAYOUT TOP VIEW

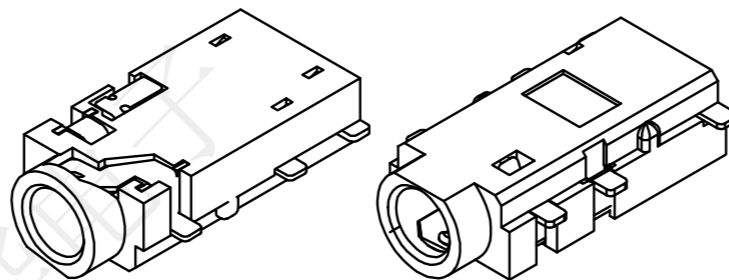
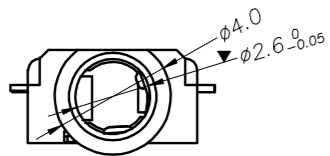

受控文件

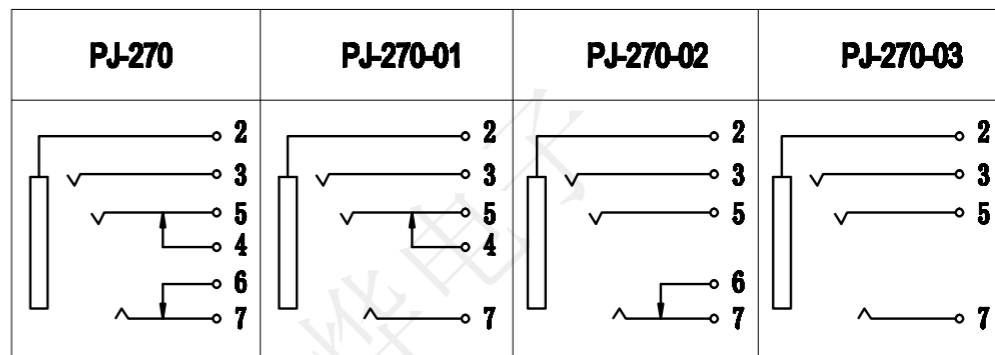
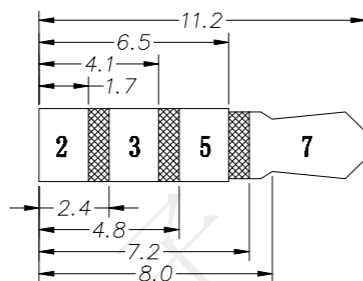
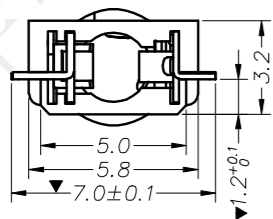
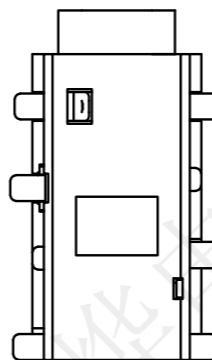
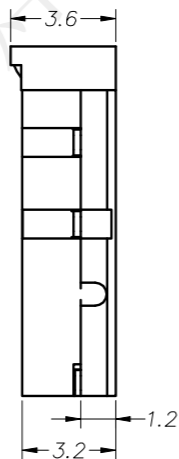
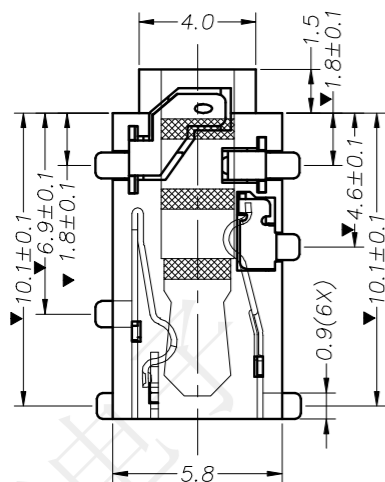

NOTES:

- REQUEST OF THE SPECIFICATION:
 - CONTACT CURRENT RATING: DC 30V, 0.5A;
 - CONTACT RESISTANCE: 30 mΩ MAX.;
 - INSULATION RESISTANCE: 100MΩ MIN.;
 - DIELECTRIC WITHSTANDING: 500V AC MIN.;
 - DURABILITY: 5,000 CYCLES MIN.;
 - CONNECTOR MATING FORCES: 20N MAX.;
 - CONNECTOR UNMATING FORCES: 3N MIN.;
 - TEMPERATURE RANGE: -30°C~+70°C

7	弹片脚	1	镀青铜	0.2T	镀金
6	插脚	1	磷铜	0.25T	镀金
5	3#脚	1	镀青铜	0.2T	镀金
4	3#开关脚	1	磷铜	0.25T	镀金
3	2#脚	1	磷铜	0.25T	镀金
2	盖脚	1	磷铜	0.2T	镀金
1	底座	1	PPA		黑色
序号	产品名称	数量	材料	规格	处理

深圳市兴烨电子有限公司
ShenZhen XingYe Electronics co., Ltd

TOLERANCE	
X.X ±0.30	X.° ±2°
XX ±0.20	.X° ±1°
XXX ±0.10	.XX° ±0.5°
UNITS	mm

APPD: 陈爱光
CHED: 施立敏
DRAW: 马洪飞

Series Name :		
Product Name :	PJ-2.5-270贴片沉板1.2编带	
Part NO:	PJL22050	
SCALE	SHEET	REV.
1:1	1/1	A1