

REV.	ECN NO.	DESCRIPTION	DRAW	APPD.	DATE
A	---				

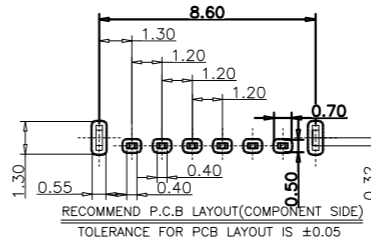
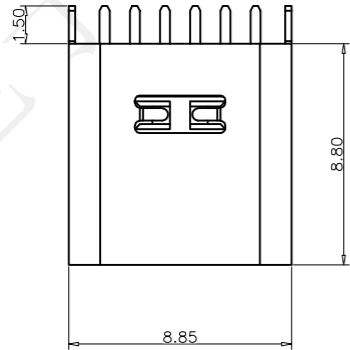
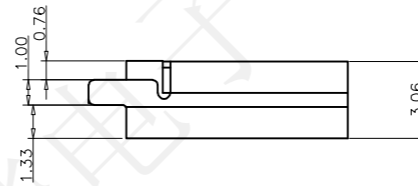
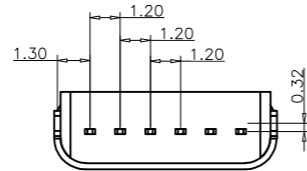
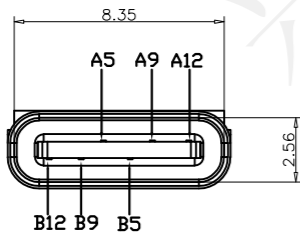
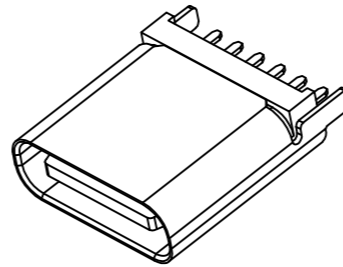
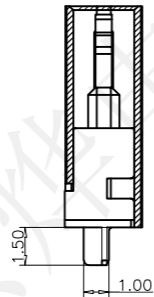
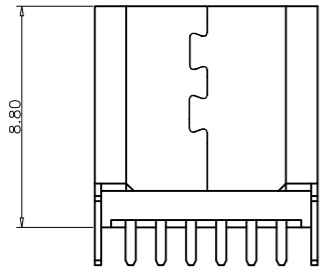

备注 (NOTE):

1 材质:

- 1.1 胶芯: LCP UL94 V-0
- 1.2 端子: C2680, T=0.2mm; 镍底, 镀金
- 1.3 外壳: 不锈钢201-H 表面镀镍

2. 电气特性:

- 2.1. 接触区: 接触电阻40mΩ Max, 允许10mΩ变化量. 测试条件: 20mv, 100mA下测量.
- 2.2. 接触电流: 3A VBUS引脚; 1.25A用于GND引脚; 其他引脚为0.25A.

2.3. 额定电压: 5V.

2.4. 耐电压: 100VAC.

2.5. 绝缘电阻: 至少100兆欧.

3. 机械性能:

- 3.1. 插入力: 0.5-2.0Kg
- 3.2. 拔出力: 0.6-2.04Kg
- 3.3. 插拔次数: 5000次.
- 4. 工作环境: -20°C to +85°C.

USB TYPE C PIN ASSIGNMENTS

PIN NUMBER	SIGNAL NAME	PIN NUMBER	SIGNAL NAME
		B12	GND
		B9	VBUS
A5	CC1	B5	CC2
A9	VBUS		
A12	GND		

TABLE:

NO	PART	Q'TY	Material
1	SHELL	1	ZINC ALLOY, NI30u"Min PLATED
2	CONTACT	6	C2680, TIN80u"/Au1u"/NI30u" PLATED
3	1MD HOUSING	1	LCP UL94 V-0 BLACK
4	CAP	1	LCP UL94 V-0 BLACK
5	WATERPROOF RING	1	SILICONE UL94 V-0 BLACK



受控文件

深圳市兴烨电子有限公司
Shenzhen XingYe Electronics co., Ltd

TOLERANCE		
X.X ±0.30	X° ±2°	APPD: 陈爱光
.XX ±0.20	.X° ±1°	CHED: 施立敏
.XXX ±0.10	.XX° ±0.5°	DRAW: 马洪飞
UNITS	mm	

Series Name :		
Product Name :	TYPE-CF-6P直插H8.8	
Part NO:	UCZ17436	
SCALE	SHEET	REV.
1:1	1/1	A1